

LM317

3-Terminal Positive Adjustable Regulator

Features

- Output Current In Excess of 1.5A
- Output Adjustable Between 1.2V and 37V
- Internal Thermal Overload Protection
- Internal Short Circuit Current Limiting
- Output Transistor Safe Operating Area Compensation
- TO-220 Package

Description

This monolithic integrated circuit is an adjustable 3-terminal positive voltage regulator designed to supply more than 1.5A of load current with an output voltage adjustable over a 1.2 to 37V. It employs internal current limiting, thermal shut-down and safe area compensation.

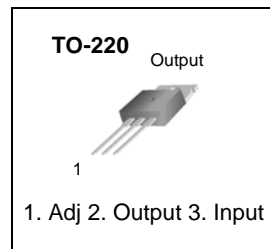

Internal Block Diagram

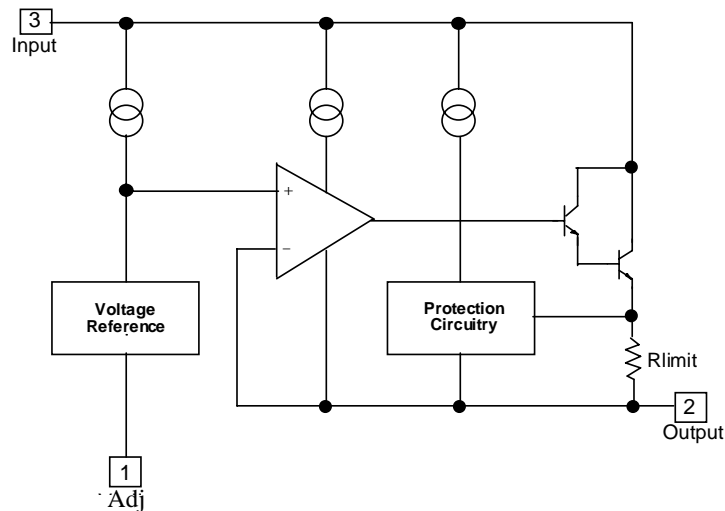

Absolute Maximum Ratings

Parameter	Symbol	Value	Unit
Input-Output Voltage Differential	$V_I - V_O$	40	V
Lead Temperature	T_{LEAD}	230	°C
Power Dissipation	P_D	Internally limited	W
Operating Junction Temperature Range	T_j	0 ~ +125	°C
Storage Temperature Range	T_{STG}	-65 ~ +125	°C
Temperature Coefficient of Output Voltage	$\Delta V_O/\Delta T$	±0.02	%/°C

Note 1: Absolute Maximum Ratings: are those values beyond which the safety of the device cannot be guaranteed. The device should not be operated at these limits. The parametric values defined in the Electrical Characteristics tables are not guaranteed at the absolute maximum ratings. The "Recommended Operating Conditions" table will define the conditions for actual device operation.

Electrical Characteristics

($V_I - V_O = 5V$, $I_O = 0.5A$, $0^\circ C \leq T_J \leq +125^\circ C$, $I_{MAX} = 1.5A$, $P_{DMAX} = 20W$, unless otherwise specified)

Parameter	Symbol	Conditions	Min.	Typ.	Max.	Unit
Line Regulation (Note2)	Rline	$T_A = +25^\circ C$ $3V \leq V_I - V_O \leq 40V$	-	0.01	0.04	%/V
		$3V \leq V_I - V_O \leq 40V$	-	0.02	0.07	%/V
Load Regulation (Note2)	Rload	$T_A = +25^\circ C$, $10mA \leq I_O \leq I_{MAX}$ $V_O < 5V$ $V_O \geq 5V$	-	18 0.4	25 0.5	mV%/V _O
		$10mA \leq I_O \leq I_{MAX}$ $V_O < 5V$ $V_O \geq 5V$	-	40 0.8	70 1.5	mV%/V _O
Adjustable Pin Current	I _{ADJ}	-	-	46	100	μA
Adjustable Pin Current Change	ΔI _{ADJ}	$3V \leq V_I - V_O \leq 40V$ $10mA \leq I_O \leq I_{MAX}$ $P_D \leq P_{MAX}$	-	2.0	5	μA
Reference Voltage	V _{REF}	$3V \leq V_{IN} - V_O \leq 40V$ $10mA \leq I_O \leq I_{MAX}$ $P_D \leq P_{MAX}$	1.20	1.25	1.30	V
Temperature Stability	STT	-	-	0.7	-	%/V _O
Minimum Load Current to Maintain Regulation	I _{L(MIN)}	$V_I - V_O = 40V$	-	3.5	12	mA
Maximum Output Current	I _{O(MAX)}	$V_I - V_O \leq 15V$, $P_D \leq P_{MAX}$ $V_I - V_O \leq 40V$, $P_D \leq P_{MAX}$ $T_A = 25^\circ C$	1.0	2.2 0.3	-	A
RMS Noise, % of V _{OUT}	e _N	$T_A = +25^\circ C$, $10Hz \leq f \leq 10kHz$	-	0.003	0.01	%/V _O
Ripple Rejection	RR	$V_O = 10V$, $f = 120Hz$ without C _{ADJ} C _{ADJ} = 10μF (Note3)	66	60 75	-	dB
Long-Term Stability, T _J = THIGH	ST	$T_A = +25^\circ C$ for end point measurements, 1000HR	-	0.3	1	%
Thermal Resistance Junction to Case	R _{θJC}	-	-	5	-	°C/W

Note 2: Load and line regulation are specified at constant junction temperature. Change in V_D due to heating effects must be taken into account separately. Pulse testing with low duty is used. (P_{MAX} = 20W)

Note 3: C_{ADJ}, when used, is connected between the adjustment pin and ground.

Typical Performance Characteristics

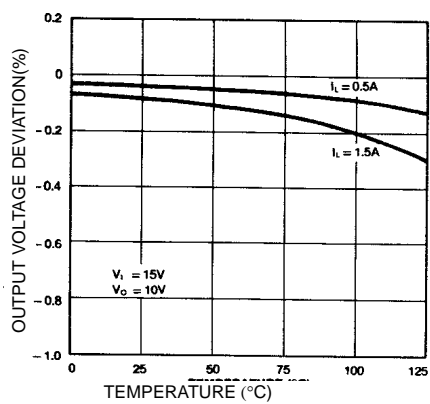

Figure 1. Load Regulation

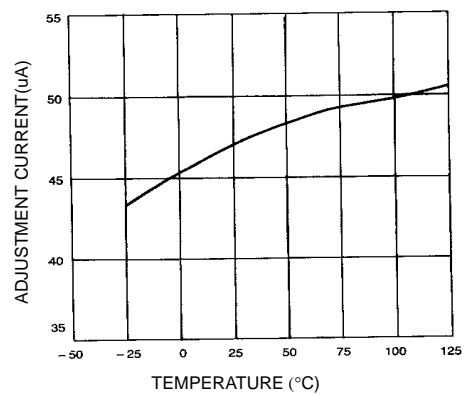

Figure 2. Adjustment Current

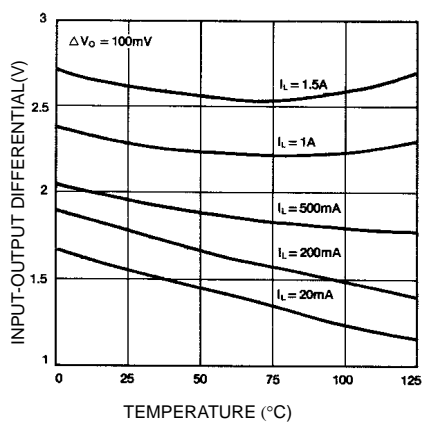

Figure 3. Dropout Voltage

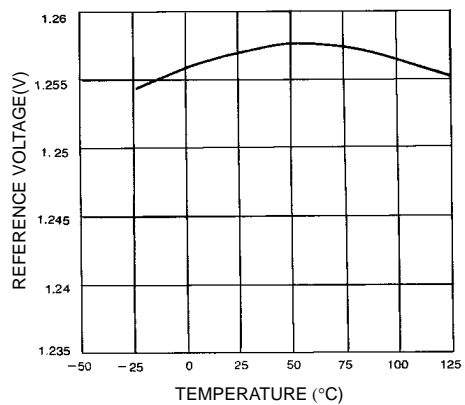
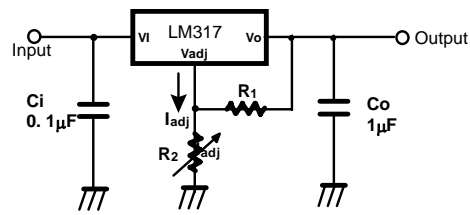

Figure 4. Reference Voltage

Typical Application



$$V_O = 1.25V (1 + R_2 / R_1) + I_{adj} R_2$$

Figure 5. Programmable Regulator

- C_i is required when regulator is located an appreciable distance from power supply filter.
 C_o is not needed for stability, however, it does improve transient response.
 Since I_{ADJ} is controlled to less than $100\mu A$, the error associated with this term is negligible in most applications.

Ordering Information

Product Number	Package	Operating Temperature
LM317T	TO-220	0°C to +125°C

DISCLAIMER

FAIRCHILD SEMICONDUCTOR RESERVES THE RIGHT TO MAKE CHANGES WITHOUT FURTHER NOTICE TO ANY PRODUCTS HEREIN TO IMPROVE RELIABILITY, FUNCTION OR DESIGN. FAIRCHILD DOES NOT ASSUME ANY LIABILITY ARISING OUT OF THE APPLICATION OR USE OF ANY PRODUCT OR CIRCUIT DESCRIBED HEREIN; NEITHER DOES IT CONVEY ANY LICENSE UNDER ITS PATENT RIGHTS, NOR THE RIGHTS OF OTHERS.

LIFE SUPPORT POLICY

FAIRCHILD'S PRODUCTS ARE NOT AUTHORIZED FOR USE AS CRITICAL COMPONENTS IN LIFE SUPPORT DEVICES OR SYSTEMS WITHOUT THE EXPRESS WRITTEN APPROVAL OF THE PRESIDENT OF FAIRCHILD SEMICONDUCTOR CORPORATION. As used herein:

1. Life support devices or systems are devices or systems which, (a) are intended for surgical implant into the body, or (b) support or sustain life, and (c) whose failure to perform when properly used in accordance with instructions for use provided in the labeling, can be reasonably expected to result in a significant injury of the user.
2. A critical component in any component of a life support device or system whose failure to perform can be reasonably expected to cause the failure of the life support device or system, or to affect its safety or effectiveness.